

**CRASH DUMMY
LOAD CELL**



**CRASH WALL
LOAD CELL**



**ADAS TEST
SYSTEM**



**MULTI-AXIS LOAD CELL
FOR AUTO DURABILITY TEST**

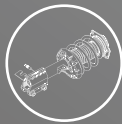

**TEST SYSTEM FOR
AUTO DURABILITY**

Sunrise Instruments

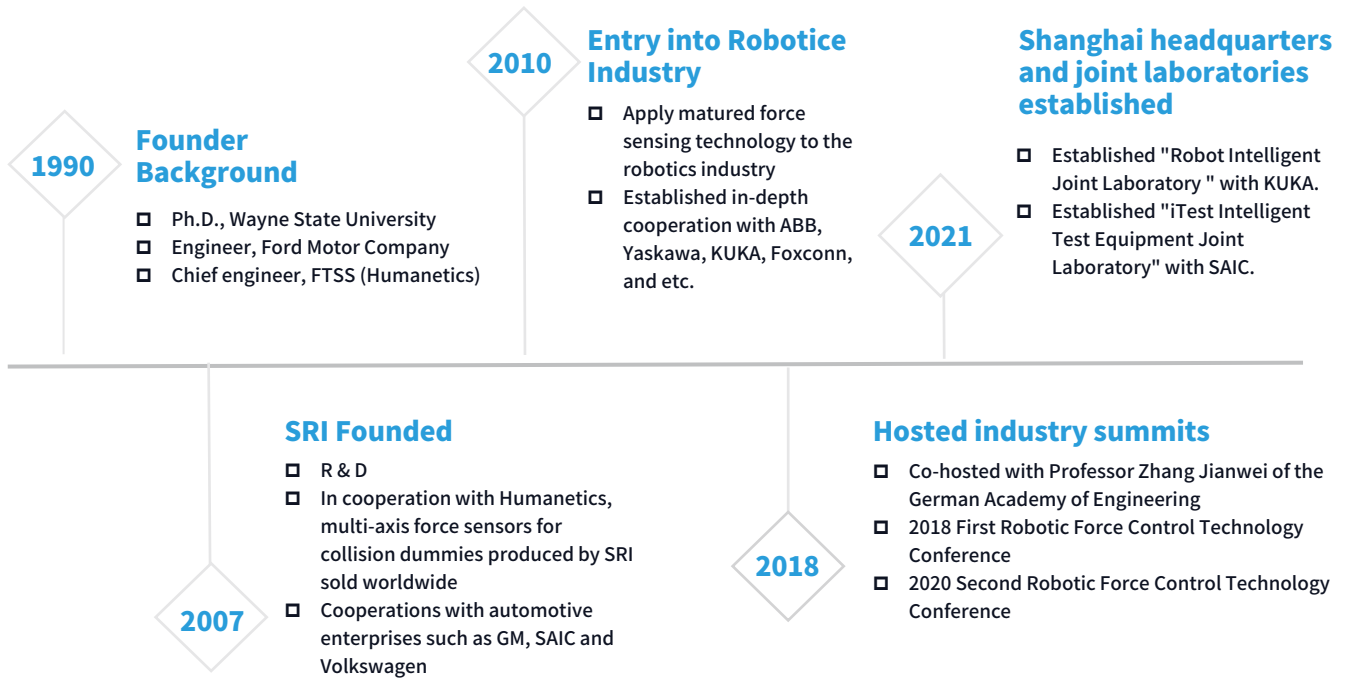

Founder Dr. York Huang is the former chief engineer of FTSS (Humanetics ATD).

SRI is a technology-intensive company integrating R&D and production. It has several patents and qualification certifications. With rich experience in robot force control applications, SRI has successfully launched the intelligent floating grinding head – iGrinder.

SRI is one of the few in the world that has a self-developed production line of automotive crash simulation dummy sensors.

SRI customers are located all over the world, coming from various fields such as automotive, robotic automation and medical. Key clients include most of the world's automotive companies, Medtronic, ABB, KUKA, YASKAWA, and top university and research labs.

Main Products



6 axis F/T load cell



Joint torque sensor



iGrinder intelligent floating head



Automotive testing sensor

Main business

Sunrise Instruments (SRI) is a technology company specialized in the development of six axis force/torque sensors, auto crash testing load cells, and robot force-controlled grinding.

We offer force measuring and force control solutions to empower robots and machines with the ability to sense and act with precision.

We commit to excellence in our engineering and products to make the robot force control easier and human travel safer.

We believe that machines + sensors will unlock endless human creativity and is the next stage of industrial evolution.

We are passionate about working with our clients to make the unknown known and push the limits of what is possible.

Crash Test Sensor

Auto Crash Dummy Load Cell
Auto Crash Wall Load Cell

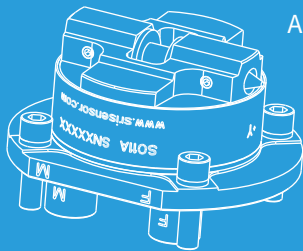

Multi-axis F/T Sensor

6 Axis Force/Torque Load Cells
3 Axis Force/Torque Load Cells
Uniaxial Load Cells
Special Load Cells

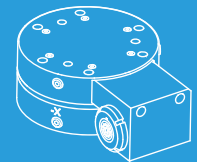

Test System for Auto Durability

Multi-axis Load Cells for
Auto Durability Test

DAS for Automotive
Durability Test

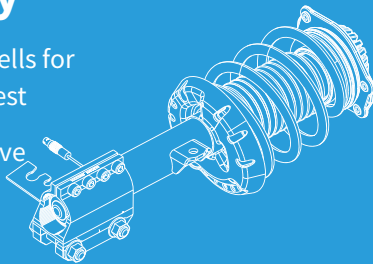

Robotic Joint Torque Sensor

Robot joint torque sensor

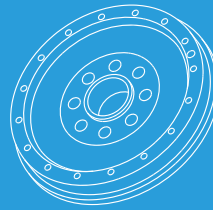

ADAS Test System

Intelligent driving robot
Target vehicle: GVT

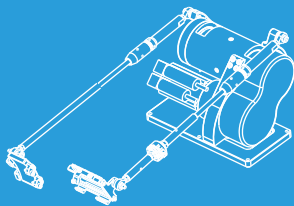

Robotic Intelligent Grinding

iGrinder[®] Axial Floating Force-control
iGrinder[®] Radial Floating Force-control Grinding



Crash Dummy Load Cell

The force sensors produced by SRI are widely used in automotive testing, such as collision testing, durability testing, structural component testing, specialized testing equipment testing, and assisted driving testing.

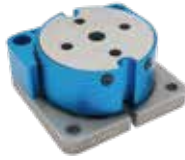

Crash Dummy Load Cell

It can measure the forces and moments acting on the head, neck, chest, waist, legs and other parts of the collision dummy. And displacement, suitable for Hybrid II/ES2/ES2-re, SID-2s, Q Series CRABI, Thor, BioRID.



Crash Wall Load Cell

S989B lightweight collision force wall: installed on a moving barrier vehicle, suitable for MPDB testing when two vehicles collide; S989A standard collision force wall: suitable for rigid frontal 100% collision testing.



Multi-axis Load Cell for Auto Durability Test

Suitable for automotive durability testing; It is divided into three parts: engine bracket three-part force sensor, gearbox three-part force sensor, ball joint force sensor, pull rod force sensor, and six parts force sensor for automotive bench.



Test System for Auto Durability

A system dedicated to road testing for automotive users; Up to 40 sampling channels, real-time uploading of PV compressed data to remote transmission devices through CAN bus; Data can also be uploaded to the PC in real-time through Ethernet; Or store the data in local storage.



ADAS Test System

Including autonomous driving robots, target vehicle GVT, and control systems, achieving all C-NCAP assisted driving function tests.

Crash Dummy Load Cell

Crash Dummies are vital in the field of automotive passive safety. There are many loadcells and displacement sensors in the dummy. Sunrise Instruments (SRI) has more than 30 years of experience in designing and manufacturing dummy sensors. SRI's dummy sensors are used in most crash labs around the world. These sensors help people accurately measure the force, moment and displacement of crash dummy body parts during crash testing.



Crash Dummy Load Cell

Model	
Hybrid III 50 th Load Cell	CRABI 12 Month Old Load Cell
Hybrid III 5 th Load Cell	Thor 50M Load Cell
Hybrid III 95 th Load Cell	Thor-5F Load Cell
Hybrid III 3 Year Old Load Cell	BioRID Load Cell
Hybrid III 6 Year Old Load Cell	FAA Dummy Load Cell
ES2/ES2-re Load Cell	Crash Wall Load Cell
SID-2s Load Cell	Other Safety Load Cell
Q Series Load Cell	Displacement Sensor

Crash Dummy Load Cell



Hybrid III 50th Load Cell

SRI Part #	Descriptions	Note	NHTSA part
S011B	6 axis upper neck LC, Hybrid III	For H3-05, H3-50, H3-95	SA572-S11
S011A	6 axis upper neck LC, Hybrid III, SRI version		
S301A	6 axis lower neck LC, adjustable, H3-50		
S302A	6 axis lower neck LC, non-adjustable, H3-50	Fixed head to spine angle	
S401A	5 axis thoracic spine LC, H3-50	Modified spine box	
S405A	3 axis lumbar spine LC, Hybrid III	For H3-50, H3-95	SAE1842
S405E	6 axis lumbar spine LC, H3-50		
S014A	Uniaxial femur LC, Hybrid III	For H3-05, H3-50, H3-95	SA572-S14
S029A	6-axis femur LC, Hybrid III	For H3-05, H3-50, H3-95	SA572-S29
S406AL	2 axis clavicle link LC, left, H3-50	Measure arm & belt force	
S406AR	2 axis clavicle link LC, right, H3-50	Measure arm & belt force	
S406BL	3 axis clavicle LC, left, H3-50	Measure arm force only	
S406BR	3 axis clavicle LC, right, H3-50	Measure arm force only	
S406CL	3 axis shoulder LC, left, H3-50	Measure seatbelt force	
S406CR	3 axis shoulder LC, right, H3-50	Measure seatbelt force	
S403A	4 axis upper tibia LC (Fx, Fz, Mx, My), Hybrid III	For H3-05, H3-50, H3-95	
S403A1	UPPER TIBIA LOAD CELL4-AXISFXFZ MXMY		
S403E	4 axis lower tibia LC(Fx, Fz, Mx, My), Hybrid III	For H3-05, H3-50, H3-95	
S403E1	LOWER TIBIA LOAD CELL		
S403F	5 axis lower tibia LC(Fx, Fy, Fz Mx, My), Hybrid III	For H3-05, H3-50, H3-95	
S403GIL	2 axis knee clevis LC, left, H3-50	Lower leg instrumentation	
S403GIR	2 axis knee clevis LC, right, H3-50	Lower leg instrumentation	
S403K1-20	Leg tube, H3-50	Lower leg instrumentation	
S403K1-25	Leg screw 1/4-28, modified	Lower leg instrumentation	
S403M1-H3-50	16 axis lower leg instrumentation, H3-50 (4 axis upper tibia and lower tibia for Fx, Fz, Mx and My, leg tube), pair - left and right	Lower leg instrumentation	
S403M2-H3-50	18 axis lower leg instrumentation, H3-50 (4 axis upper tibia (Fx, Fz, Mx, My) and 5 axis lower tibia (Fx, Fy, Fz, Mx, My) and leg tube, pair - left and right	Lower leg instrumentation	

Hybrid III 5th Load Cell

SRI Part #	Descriptions	Note	NHTSA part
S011B	6 axis upper neck LC, Hybrid III	For H3-05, H3-50, H3-95	SA572-S11
S027A	5 axis lower neck LC, non-adjustable, H3-05	Fixed head to torso angle	SA572-S27
S027B	6 axis lower neck LC, non-adjustable, H3-05	Fixed head to torso angle	
S027E	6 axis lower neck LC, adjustable, H3-05	Adjustable head-spine angle	
S028A	5 axis thoracic spine LC, H3-05	Accept standard spine box	SA572-S28
S015A	5 axis lumbar spine LC, H3-05	For H3-05	SA572-S15
S015B	3 axis lumbar spine LC, H3-05	For H3-05	
S014A	Uniaxial femur LC, Hybrid III	For H3-05, H3-50, H3-95	SA572-S14
S029A	6 axis femur LC, Hybrid III	For H3-05, H3-50, H3-95	SA572-S29
S016A	Anterior superior iliac spine LC, pair, H3-05	For H3-05	SA572-S16
S016AL	Anterior superior iliac spine LC, left, H3-05	For H3-05	
S016AR	Anterior superior iliac spine LC, right, H3-05	For H3-05	
S409BL	3 axis clavicle LC, left, H3-05	Measure arm & seatbelt	
S409BR	3 axis clavicle LC, right, H3-05	Measure arm & seatbelt	
S403A	4 axis upper tibia LC (Fx, Fz, Mx, My), Hybrid III	For H3-05, H3-50, H3-95	
S403E	4 axis lower tibia LC (Fx, Fz, Mx, My), Hybrid III	For H3-05, H3-50, H3-95	
S403F	5 axis lower tibia LC (Fx, Fy, Fz, Mx, My), Hybrid III	For H3-05, H3-50, H3-95	
S403G2L	2 axis knee clevis LC, left, H3-05	Lower leg instrumentation	
S403G2R	2 axis knee clevis LC, right, H3-05	Lower leg instrumentation	
S403K2-20	Leg tube, H3-05	Lower leg instrumentation	
S403K1-25	Leg screw 1/4-28, modified	Lower leg instrumentation	
S403M3-H3-05	16 axis lower leg instrumentation, H3-05 (4 axis upper tibia and lower tibia for Fx, Fz, Mx and My, leg tube), pair - left and right	Lower leg instrumentation	
S403M4-H3-05	18 axis lower leg instrumentation, H3-05 (4 axis upper tibia (Fx, Fz, Mx, My) and 5 axis lower tibia (Fx, Fy, Fz, Mx, My) and leg tube, pair - left and right	Lower leg instrumentation	

Hybrid III 3 Year Old Load Cell

SRI Part #	Descriptions	Note	NHTSA part #
S019A	6 axis upper/lower neck LC, H III 3yr	Attention to polarity	SA572-S19
S021A	2 axis shoulder LC, Hybrid III 3yr	For Hybrid III 3yr	SA572-S21
S020A	6 axis lumbar spine LC, Hybrid III 3yr	For Hybrid III 3yr	SA572-S20
S018A	2 axis pubic LC, Hybrid III 3yr	For Hybrid III 3yr	SA572-S18
S022A	Uniaxial acetabulum LC, Hybrid III 3yr	For Hybrid III 3yr	SA572-S22
S017A	2 axis ASIS LC, Pair for left and right, Hybrid III 3yr	For Hybrid III 3yr	SA572-S17

Hybrid III 6 Year Old Load Cell

SRI Part #	Descriptions	Note	NHTSA part #
S011B	6 axis upper neck LC, Hybrid III	For H3-05, H3-50, H3-95	SA572-S11
S026A	6 axis lower neck LC, Hybrid III 6yr	For Hybrid III 6yr	SA572-S26
S012A	6 axis lumbar spine LC, Hybrid III 6yr	For Hybrid III 6yr	SA572-S12
S013A	2 axis ASIS LC, Pair for left and right, Hybrid III 6yr	For Hybrid III 6yr	SA572-S13
S010A	Uniaxial femur LC, Hybrid III 6yr	For Hybrid III 6yr	SA572-S10

Hybrid III 95th Load Cell

SRI Part #	Descriptions	Note	NHTSA part #
S011B	6 axis upper neck LC, Hybrid III	For H3-05, H3-50, H3-95	SA572-S11
S320A	6 axis lower neck LC, H3-95	Fixed head to spine angle	SAE1794
S405A	3 axis lumbar spine LC, Hybrid III	For H3-50, H3-95	SAE1842
S430A	5 axis thoracic spine LC, H3-95		SAE1911
S014A	Uniaxial femur LC, Hybrid III	For H3-05, H3-50, H3-95	SA572-S14
S029A	6 axis femur LC, Hybrid III	For H3-05, H3-50, H3-95	SA572-S29
S403A	4 axis upper tibia LC (Fx, Fz, Mx, My), Hybrid III	For H3-05, H3-50, H3-95	
S403E	4 axis lower tibia LC(Fx, Fz, Mx, My), Hybrid III	For H3-05, H3-50, H3-95	
S403F	5 axis lower tibia LC(Fx, Fy, Fz, Mx, My), Hybrid III	For H3-05, H3-50, H3-95	
S403G3L	2 axis knee clevis LC, left, H3-95	Lower leg instrumentation	
S403G3R	2 axis knee clevis LC, right, H3-95	Lower leg instrumentation	
S403K3-20	Leg tube, H3-95	Lower leg instrumentation	
S403K1-25	Leg screw 1/4-28, modified	Lower leg instrumentation	
S403M5-H3-95	16 axis lower leg instrumentation, H3-95 (4 axis upper tibia and lower tibia for Fx, Fz, Mx and My, leg tube), pair - left and right	Lower leg instrumentation	
S403M6-H3-95	18 axis lower leg instrumentation, H3-95 (4 axis upper tibia (Fx, Fz, Mx, My) and 5 axis lower tibia (Fx, Fy, Fz, Mx, My) and leg tube), pair - left and right	Lower leg instrumentation	

ES2/ES2-re Load Cell

SRI Part #	Descriptions	Note	NHTSA part #
S070A	6 axis upper neck LC, ES2/ES2-re	For ES2/ES2-re	SA572-S70
S071A	6 axis lower neck LC, ES2/ES2-re	For ES2/ES2-re	SA572-S71
S074A	4 axis T12 LC, ES2/ES2-re	For ES2/ES2-re	SA572-S74
S440A	4 axis back plate LC, ES2	For ES2	
S073A	4 axis back plate LC, ES2-re	For ES2-re	SA572-S73
S072A	3 axis shoulder LC, ES2/ES2-re	For ES2/ES2-re	SA572-S72
S075A	Uniaxial abdominal LC, ES2/ES2-re	For ES2/ES2-re	SA572-S75
S076A	3 axis lumbar spine LC, ES2/ES2-re	For ES2/ES2-re	SA572-S76
S076B	3 axis lumbar spine LC, ES2/ES2-re, High Capacity	For ES2/ES2-re	SA572-S76
S077A	Uniaxial pubic LC, ES2/ES2-re	For ES2/ES2-re	SA572-S77
S029B	6 axis femur LC, aluminum cap, ES2/ES2-re	For ES2/ES2-re	

Q Series Load Cell

SRI Part #	Descriptions	Note	NHTSA part #
S407A	6 axis neck LC, Q series	Upper & lower neck, lumbar	
S407B	6 axis neck LC, High capacity, Q series	High capacity, steel version	
S407F	ASIS load cell, Fx, My, Q6/Q10		
S407GL	Shoulder/lumbar load cell, Left, Fx, Fy, Fz, Q10		
S407GR	Shoulder/lumbar load cell, Right, Fx, Fy, Fz, Q10		
S407H	Acetabulum load cell, Fy, Q10	High capacity, steel version	

SID-2s Load Cell

SRI Part #	Descriptions	Note	NHTSA part #
S011B	6 axis upper neck LC, Hybrid III	For H3-05, H3-50, H3-95	SA572-S11
S060A	6 axis lower neck LC, SID-2s	Fixed head to spine angle	SA572-S60
S060E	6 axis lower neck LC, Adjustable, SID-2s	Adjustable d head to spine	
S060EK	6 axis lower neck LC, Adjustable, SID-2s, DTI DAS	Adjustable d head to spine	
S062A	3 axis shoulder LC, SID-2s	For SID-2s	SA572-S62
S064A	6 axis lumbar spine LC, SID-2s	For SID-2s	SA572-S64
S066A	Uniaxial iliac wing LC, SID-2s	For SID-2s	SA572-S66
S068A	Uniaxial acetabulum LC, SID-2s	For SID-2s	SA572-S68
S029A	6 axis femur LC, Hybrid III	For H3-05, H3-50, H3-95	SA572-S29
S069A	Uniaxial Pubic LC, SID-2s	For SID-2s	
S5769AL	Upper femur LC, left, SID-2s	For SID-2s	
S5769AR	Upper femur LC, right, SID-2s	For SID-2s	
S3676A	Uniaxial rib LC, SID-2s	For SID-2s	

CRABI 12 Month Old Load Cell

SRI Part #	Descriptions	Note	NHTSA part #
S023A	6 axis neck/lumbar LC, Crabi 12/18 month	For Crabi 12/18 month	SA572-S23
S025A	2 axis shoulder LC, Crabi 12 month old	For Crabi 12 month	SA572-S25
S024A	2 axis pubic LC, Crabi 12 month old	For Crabi 12 month	SA572-S24

Thor-50M Load Cell

SRI Part #	Descriptions	Note	NHTSA part #
S112A	Uniaxial skull spring LC, Thor-50M	Compression only	SA572-S112
S112D	Face load cell, Fx, Thor-50M		
S112F	Clavicle load cell (2X) FX & (2X) FZ, Thor-50M		
S112FL	Clavicle load cell (2X) FX & (2X) FZ, left, Thor-50M		
S112FR	Clavicle load cell (2X) FX & (2X) FZ, right, Thor-50M		
S119AL	2 axis Asis load cell, Fx,My, left, Thor-50M		
S119AR	2 axis Asis load cell, Fx,My, right, Thor-50M		
S110A	6 axis upper neck LC, Thor-50M	For Thor 50M	SA572-S110
S111A	6 axis lower neck LC, Thor-50M	Non-adjustable angle	SA572-S111
S127A	5 axis thoracic spine LC, Thor-50M	For Thor 50M	SA572-S127
S128A	3 axis acetabulum LC, left, Thor-50M	For Thor 50M	SA572-S128
S129A	3 axis acetabulum LC, right, Thor-50M	For Thor 50M	SA572-S129
S120A	6 axis femur LC, Thor-50M	For Thor 50M	SA572-S120
S032A	5 axis upper tibia LC, Thor-50M	Lower leg instrumentation	SA572-S32
S033A	5 axis lower tibia LC, Thor-50M	Lower leg instrumentation	SA572-S33

BioRID Load Cell

SRI Part #	Descriptions	Note	NHTSA part #
S6014A	6 axis upper neck LC, BioRID-II	For BioRID-II	
S6014B	3 AXIS T1 THORACIC VERTEBRAE LOADCELL BIORID	For BioRID-II	

Thor-5F Load Cell

SRI Part #	Descriptions	Note	NHTSA part #
S105A	6 axis upper neck LC, Thor-5F	For Thor-5F	SA572-S105
S106A	6 axis lower neck LC, Thor-5F	For Thor-5F	SA572-S106
S165A	4 axis clavicle LC, left, Thor-5F	For Thor-5F	SA572-S165
S166A	4 axis clavicle LC, right, Thor-5F	For Thor-5F	SA572-S166
S107A	6 axis thoracic spine LC, Thor-5F	For Thor-5F	SA572-S107
S159A	2 axis ASIS LC, left, Thor-5F	For Thor-5F	SA572-S159
S160A	2 axis ASIS LC, right, Thor-5F	For Thor-5F	SA572-S160
S109A	3 axis acetabulum LC, left, Thor-5F	For Thor-5F	SA572-S109
S108A	3 axis acetabulum LC, right, Thor-5F	For Thor-5F	SA572-S108
S063A	6 axis femur LC, Thor-5F	For Thor-5F	SA572-S63
S103A	5 axis upper tibia LC, Thor-5F	For Thor-5F	SA572-S103
S104A	5 axis lower tibia LC, Thor-5F	For Thor-5F	SA572-S104

FAA Dummy Load Cell

SRI Part #	Descriptions	Note	NHTSA part #
S470	3 axis lumbar LC, FAA dummy	For FAA dummy SF	
S470B	6 axis lumbar LC, FAA dummy	For FAA dummy SF	
S470C	3 axis lumbar LC, FAA dummy	For FAA dummy	
S470D	6 axis lumbar LC, FAA dummy	For FAA dummy	

Crash Wall Load Cell

SRI Part #	Descriptions	Note	NHTSA part #
S989A1	3 axis crash wall LC, 300kN, standard, 9.2kg	For rigid barrier	
S989B1	3 axis crash wall LC, 50kN, light weight, 3.9kg	For MPDB barrier	
S989C	3 axis crash wall LC, 400kN, 9kg	Different configuration	
S989D1	5 axis crash wall LC, FXFYFZ,MYMZ,400kN,9kg	Different configuration	
S989E1	5 axis crash wall LC, FXFYFZ,MYMZ,100kN,3.9kg	For MPDB barrier	
S989E3	6 axis crash wall LC, CORNER ELEMENT,400kN	For Small Overlap barrier	

Other Safety Load Cell

SRI Part #	Descriptions	Note	NHTSA part #
S6011A	6 axis seat pan load cell, 44480N	For general testing	
S6011B	6 axis seat pan load cell, 10kN	For general testing	

Seatbelt Loadcell

SRI Part #	Descriptions	Note	NHTSA part #
S901A	Seatbelt load cell, 16kN, 97g	Meet E-NCAP requirement	
S901B	Seatbelt loadcell 500N		
S901C	Seatbelt loadcell 16KN		

Displacement Sensor

SRI Part #	Descriptions	Note	NHTSA part #
S6107AL	Knee slider string potentiometer, left	For Hybrid III	
S6107AR	Knee slider string potentiometer, right	For Hybrid III	
S6107AU	Knee slider string potentiometer, universal		
S6107B	Chest potentiometer, H3	For Hybrid III	
S6107B3	Chest deflection transducer assembly, H3-50	78051-317	
S6107B2	Chest deflection transducer assembly, H3-05		
S6107B4	Chest deflection transducer assembly, H3-95		
S6107C	Potentiometer, OD 3/8", Length 3", ES2&SID2S		
S6107C2	Potentiometer, OD 3/8", Length 3", Rib1 & 6, SID2s		
S6107C3	Potentiometer, OD 3/8", Length 3", Rib2-5, SID2s		
S6107D	Potentiometer, OD 1/2", Thor		
S6107E	String Potentiometer, 51mm, Q		
S6107H3	Potentiometer, assembly, ES-2		
S6107F	Chest Potentiometer, OD 1/2", H3-03, H3-06	For Hybrid III	
S6107F3	Chest potentiometer Assembly H3-03		
S6107F4	Chest potentiometer Assembly H3-06	For Hybrid III	
S6201B3	IR TRACC 1D Assembly, Q6		
S6201C3	IR TRACC 2D Assembly, Q10		
S6201A01	IR TRACC, 90MM, CHEST UPPER LEFT, Thor-50M		
S6201A02	IR TRACC, 90MM, CHEST UPPER RIGHT, Thor-50M		
S6201A03	IR TRACC, 90MM, CHEST LOWER LEFT, Thor-50M		
S6201A04	IR TRACC, 90MM, CHEST LOWER RIGHT, Thor-50M		
S6201E01	IR TRACC, 123MM, ABDOMEN LEFT, Thor-50M		
S6201E02	IR TRACC, 123MM, ABDOMEN RIGHT, Thor-50M		

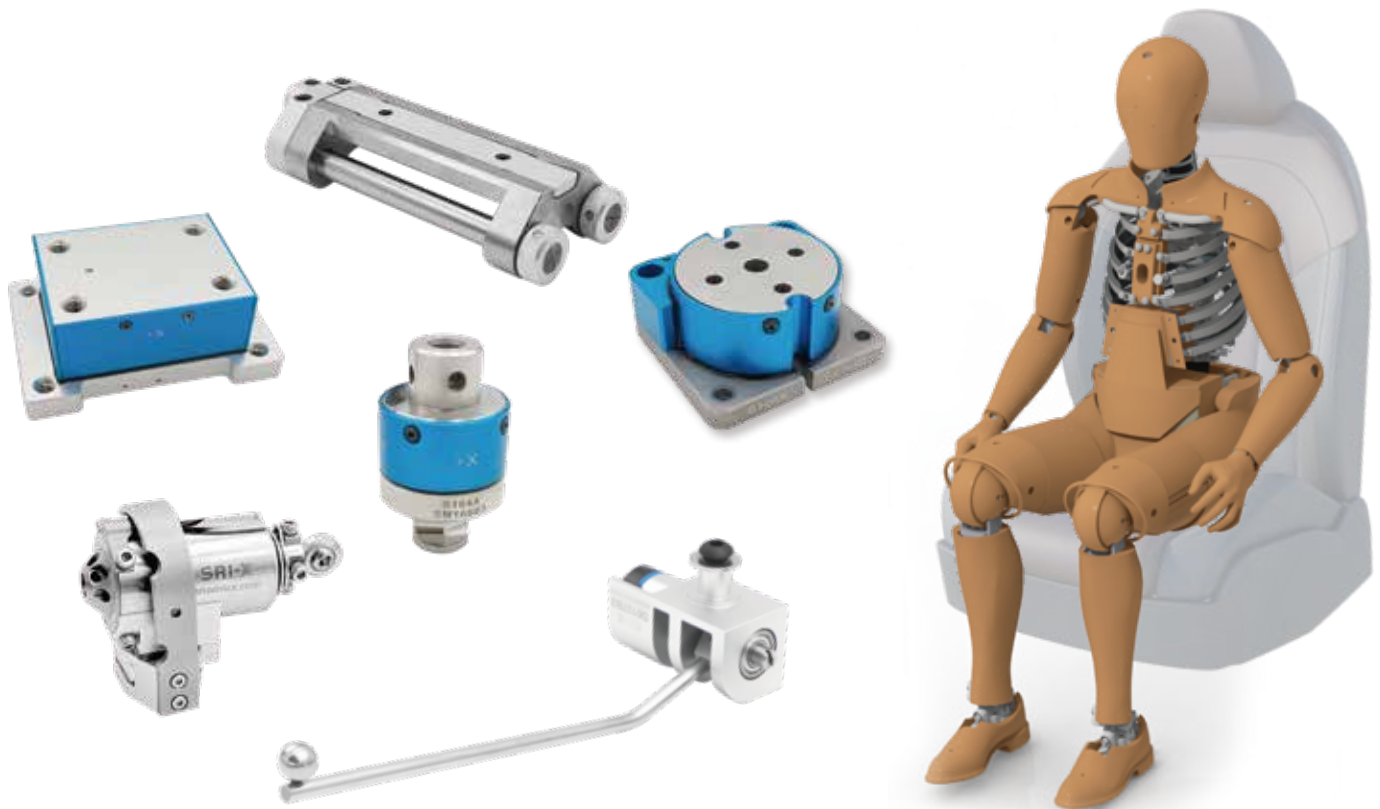

Crash Wall Load Cell

Crash wall load cell measures the collision forces in the XYZ directions, which is a key device in the field of automotive compatibility research and regulation.

SRI has two types of crash wall load cells: standard version and lightweight version. The sensor capacity ranges from 50KN to 500KN, with dimensions of 125mm x 125mm.

Lightweight MPDB crash wall: installed on a mobile barrier vehicle, suitable for vehicle-to-vehicle MPDB testing; standard frontal crash wall: suitable for 100% frontal crash testing.

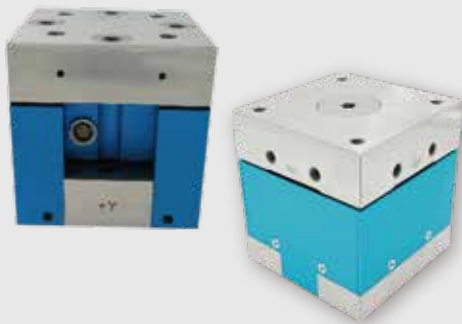

Standard version:S989C/S989A1

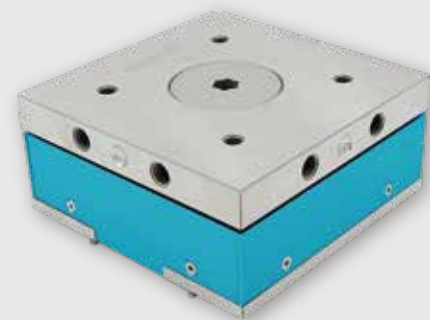
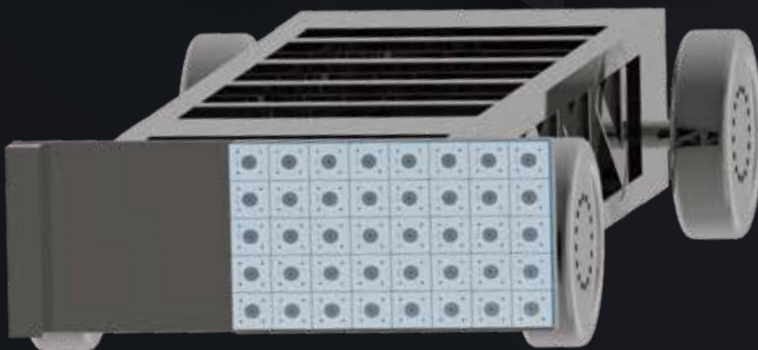

lightweight version:S989B1

The lightweight model S989B1 weighs only 3.9kg, making it especially suitable for MPDB testing.

Crash Wall Load Cell

The range of the sensor covers from 50kN to 500kN, with dimensions of 125mm x 125mm, making it very convenient to create a rigid collision force wall.

Standard type weight is 9.2kg, used for rigid 100% frontal impact tests; lightweight type weight is only 3.9kg, especially suitable for MPDB tests.

The SRI crash wall load cell supports analog and digital output, and the digital output sensor is internally integrated with the iDAS data acquisition system.

Advantages of SRI crash wall load cell

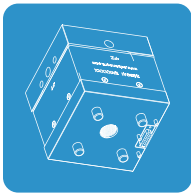

Excellent performance

Non-linearity $\leq 0.5\%$
Hysteresis $\leq 0.5\%$
Crosstalk $\leq 2\%$
Resonant frequency
3200 Hz

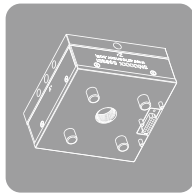

Upgradable

Upgradable to NHTSA version, obtaining an average crash force height AHOF.

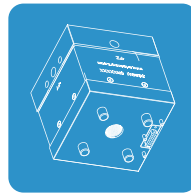

More applications

Standard type, suitable for frontal rigid collision tests; lightweight type, suitable for vehicle-to-vehicle MPDB tests.

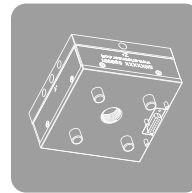

Reliable and easy to use

Front installation, easy maintenance and disassembly; internal digital output of the data acquisition system can be integrated with high reliability.

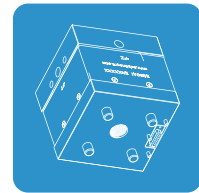

Calibration service

SRI provides comprehensive and easily accessible calibration services.



SRI Part #	Descriptions	Note	NHTSA part #
S989A1	3 axis crash wall LC, 300kN, standard, 9.2kg	For rigid barrier	
S989B1	3 axis crash wall LC, 50kN, light weight, 3.9kg	For MPDB barrier	
S989C	3 axis crash wall LC, 400kN, 9kg	Different configuration	
S989D1	5 axis crash wall LC, FXFYFZ,MYMZ,400kN,9kg	Different configuration	
S989E1	5 axis crash wall LC, FXFYFZ,MYMZ,100kN,3.9kg	For MPDB barrier	
S989E3	6 axis crash wall LC, CORNER ELEMENT,400kN	For Small Overlap barrier	

Frontal impact crash wall

Used for a 100% rigid wall crash test.

Sensor capacity ranges from 50KN to 500KN, with dimensions of 125mm x 125mm, making it very convenient to create a rigid collision force wall.

Standard type weight is 9.2kg, used for rigid 100% frontal crash tests; lightweight type weight is only 3.9kg, especially suitable for MPDB tests.

The SRI collision force wall sensor supports analog and digital output, and the digital output sensor is internally integrated with the iDAS data acquisition system.

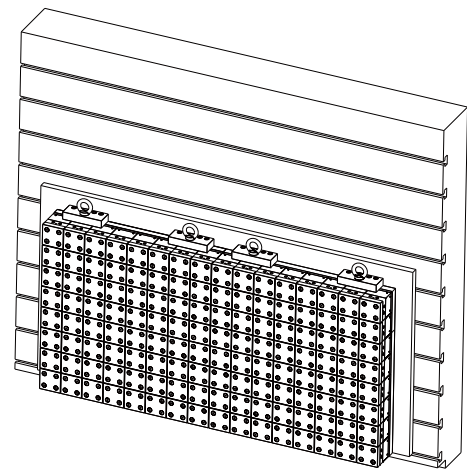

MPDB crash force wall

Used for MPDB test

The SRI collision force wall sensor supports analog and digital output, and the digital output sensor is internally integrated with the iDAS data acquisition system.

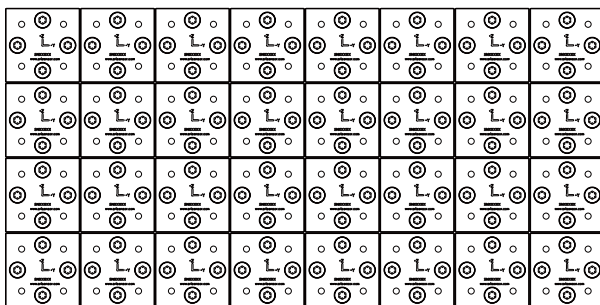

Pole impact force wall

Used for side pole crash test

The vertical crash force wall test is a key part of automotive collision safety assessment, used for side vertical crash tests. Its design and function aim to comprehensively evaluate the vehicle's ability to protect occupants during a collision. The sensor weighs 9.2 kg and forms a vertical collision force wall.

The SRI crash wall load cell supports both analog and digital output, with the digital output sensors integrating the iDAS data acquisition system.

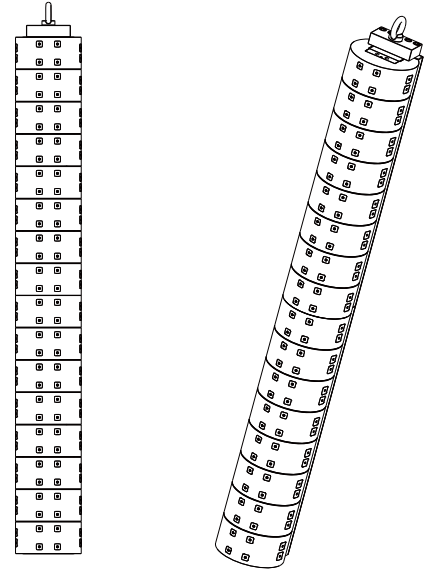
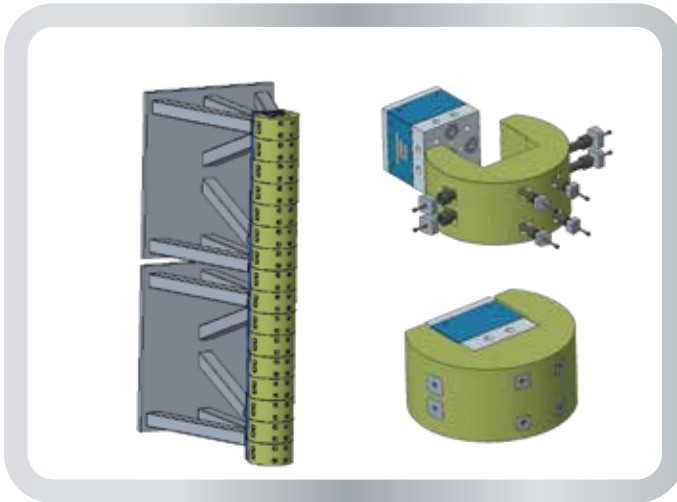

Small overlapped crash force wall

Large range 5-axis load cell

Small overlapped crash force wall consists of multiple large range 5-axis load cells, which are used to calculate the crash point and direction of the impact force for each sensor on the vehicle's collision surface. FY capacity has increased from 100kN to 400kN.

The SRI crash force wall supports both analog and digital outputs, and the digital output sensors are internally integrated with the iDAS data acquisition system.

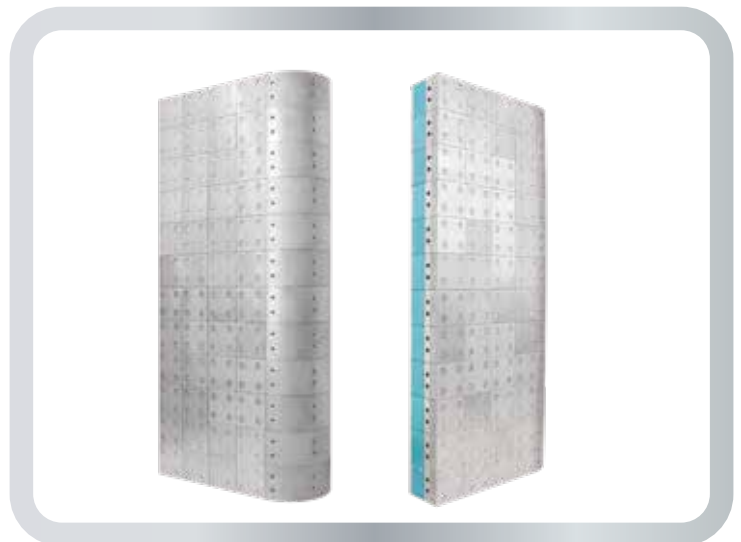
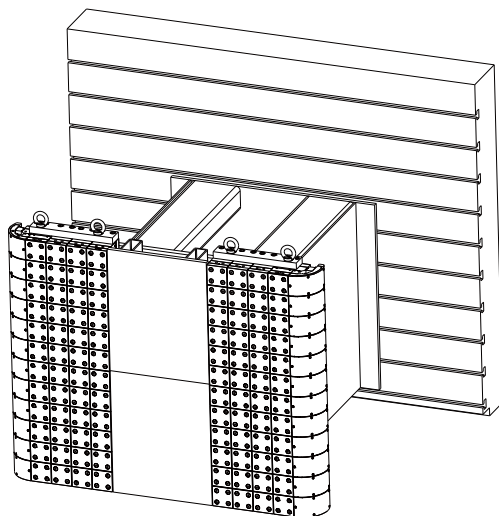

CONTACT US



★ Main Office ● Office ● Customers



China Main Office

Address: No.176, Gaoji Rd, Songjiang District, Shanghai, China
Tel: +86-21-6127-6380
Email: sri@srisensor.com



USA Office

Address: 8534 N Canton Center Rd, Canton, MI 48187, USA
Tel: +1-947-214-0359
Email: marcus@srisensor.com



China Taiwan (Sales)

MEMS TECHNOLOGY CORP.
Address: 5-9, 3rd Floor, No. 6, Section 1, Zhongxing Road, Wugu District, New Taipei City 248312, Taiwan
Tel: ++886-2-8976-9066 #223
Mobile: +886-2-8976-9099



KOREA (Sales)

Kyoung-Tae Min, KTINC
Address: Rm 1406, ACE Pyeongchon Tower 361 SIMIN-DAERO, DONGAN-GU, ANYANG-SI, GYEONGGI-DO, S.KOREA.
Mobile: 010-8650-8498
Tel: +31-383-8498
E-mail: info@ktinc.kr



Japan (Sales)

K Futami, JASTI CO., LTD
Address: 2-4-3, Miyoshi, Koto-ku, Tokyo, 135-0022, Japan
Tel: +81-(0)3-5245-3661
Email: k_futami@jasti.co.jp